

## High efficiency ultrafast diode

### Main product characteristics

$I_{F(AV)}$	2 x 30 A
$V_{RRM}$	200 V
$T_j$ (max)	175° C
$V_F$ (typ)	0.75 V
$t_{rr}$ (typ)	22 ns

### Features and benefits

- Suited for SMPS
- Low losses
- Low forward and reverse recovery times
- High surge current capability
- High junction temperature

### Description

Dual center tab rectifier suited for switch mode power supplies and high frequency DC to DC converters.

Packaged in TO-247 and TOP31, this device is intended for use in low voltage, high frequency inverters, free wheeling and polarity protection

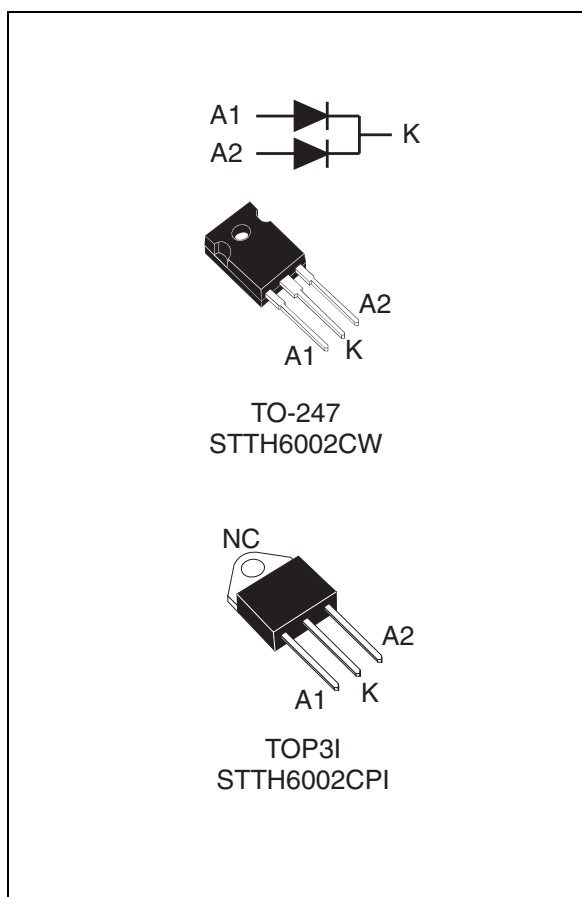

### Order codes

Part Number	Marking
STTH6002CW	STTH6002C
STTH6002CPI	STTH6002C

# 1 Characteristics

**Table 1. Absolute ratings (limiting values at  $T_j = 25^\circ\text{C}$ , unless otherwise specified)**

Symbol	Parameter		Value	Unit	
$V_{RRM}$	Repetitive peak reverse voltage		200	V	
$I_{F(RMS)}$	RMS forward current		50	A	
$I_{F(AV)}$	Average forward current, $\delta = 0.5$	TO-247	Per diode $T_c = 140^\circ\text{C}$	30	A
			Per device $T_c = 125^\circ\text{C}$	60	
		TOP3I	Per diode $T_c = 120^\circ\text{C}$	30	
			Per device $T_c = 105^\circ\text{C}$	60	
$I_{FSM}$	Surge non repetitive forward current	$t_p = 10\text{ ms}$ Sinusoidal	330	A	
$T_{stg}$	Storage temperature range		-65 to +175	$^\circ\text{C}$	
$T_j$	Maximum operating junction temperature		175	$^\circ\text{C}$	

**Table 2. Thermal parameters**

Symbol	Parameter		Value	Unit	
$R_{th(j-c)}$	Junction to case	TO-247	Per diode	1.2	$^\circ\text{C/W}$
			Total	0.8	
		TOP3I	Per diode	1.8	
			Total	1.20	
$R_{th(c)}$	Coupling	TO-247	0.4		
		TOP3I	0.6		

When the two diodes 1 and 2 are used simultaneously:

$$\Delta T_j(\text{diode 1}) = P(\text{diode 1}) \times R_{th(j-c)} (\text{Per diode}) + P(\text{diode 2}) \times R_{th(c)}$$

**Table 3. Static electrical characteristics**

Symbol	Parameter	Test conditions		Typ	Max.	Unit
$I_R^{(1)}$	Reverse leakage current	$T_j = 25^\circ\text{C}$	$V_R = V_{RRM}$		30	$\mu\text{A}$
		$T_j = 125^\circ\text{C}$		30	300	
$V_F^{(2)}$	Forward voltage drop	$T_j = 25^\circ\text{C}$	$I_F = 30\text{ A}$		1.05	V
			$I_F = 60\text{ A}$		1.18	
		$T_j = 150^\circ\text{C}$	$I_F = 30\text{ A}$	0.75	0.84	
			$I_F = 60\text{ A}$	0.9	0.99	

1. Pulse test:  $t_p = 5\text{ ms}$ ,  $\delta < 2\%$

2. Pulse test:  $t_p = 380\text{ }\mu\text{s}$ ,  $\delta < 2\%$

To evaluate the conduction losses use the following equation:

$$P = 0.69 \times I_{F(AV)} + 0.005 I_{F(RMS)}^2$$

**Table 4. Dynamic characteristics**

Symbol	Parameter	Test conditions	Typ	Max.	Unit
$t_{rr}$	Reverse recovery time	$I_F = 1\text{ A}$ , $dI_F/dt = 200\text{ A}/\mu\text{s}$ , $V_R = 30\text{ V}$ , $T_j = 25^\circ\text{C}$	22	27	ns
$I_{RM}$	Reverse recovery current	$I_F = 30\text{ A}$ , $dI_F/dt = 200\text{ A}/\mu\text{s}$ , $V_R = 160\text{ V}$ , $T_j = 125^\circ\text{C}$	7.6	9.5	A
$t_{fr}$	Forward recovery time	$I_F = 30\text{ A}$ , $dI_F/dt = 200\text{ A}/\mu\text{s}$ , $V_{FR} = 1.1 \times V_{Fmax}$ , $T_j = 25^\circ\text{C}$		220	ns
$V_{FP}$	Forward recovery voltage	$I_F = 30\text{ A}$ , $dI_F/dt = 200\text{ A}/\mu\text{s}$ , $T_j = 25^\circ\text{C}$	2.5		V

**Figure 1. Peak current versus duty cycle (per diode)**

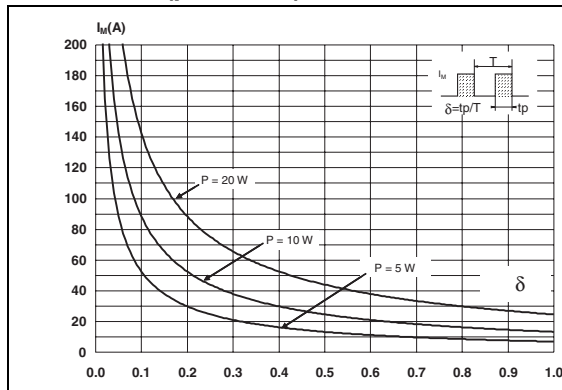

**Figure 2. Forward voltage drop versus forward current (per diode)**

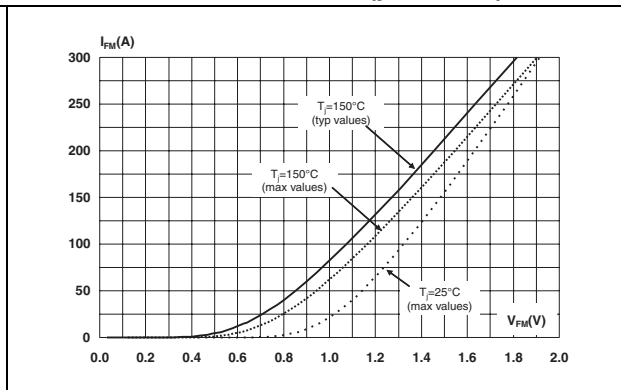

**Figure 3. Relative variation of thermal impedance junction to case versus pulse duration**

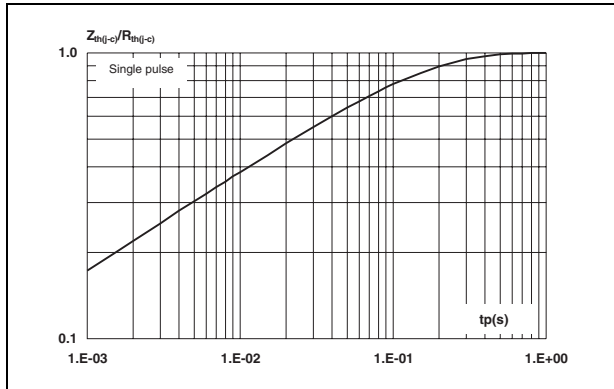

**Figure 4. Junction capacitance versus reverse applied voltage (typical values)**

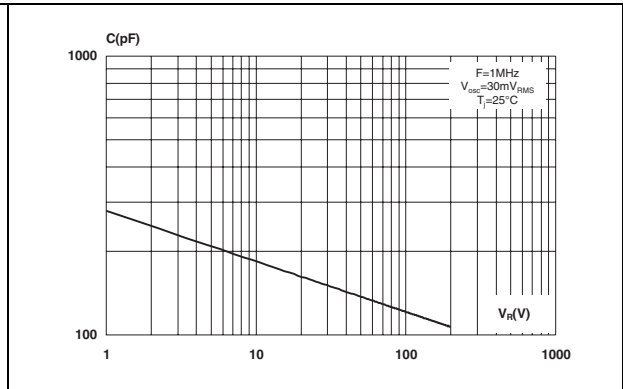

**Figure 5. Reverse recovery charges versus  $di_F/dt$  (typical values)**

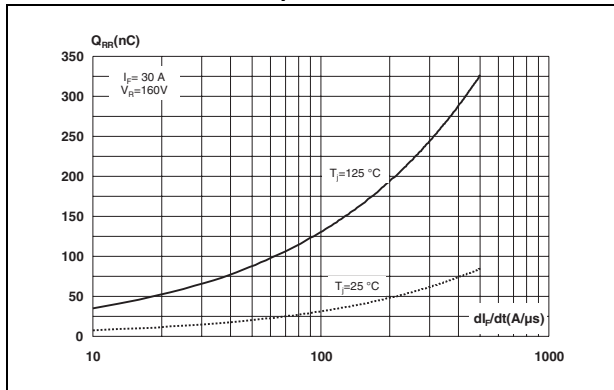

**Figure 6. Reverse recovery time versus  $di_F/dt$  (typical values)**

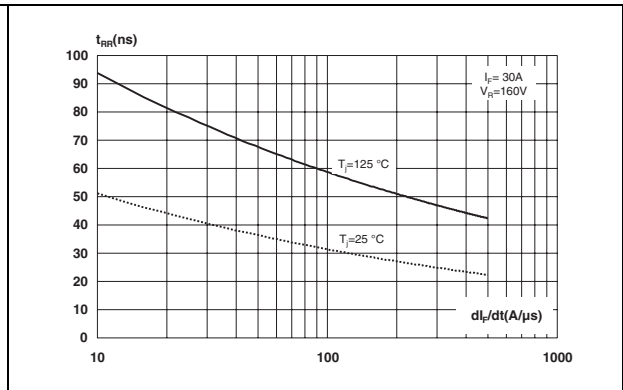

**Figure 7. Peak reverse recovery current versus  $di_F/dt$  (typical values)**

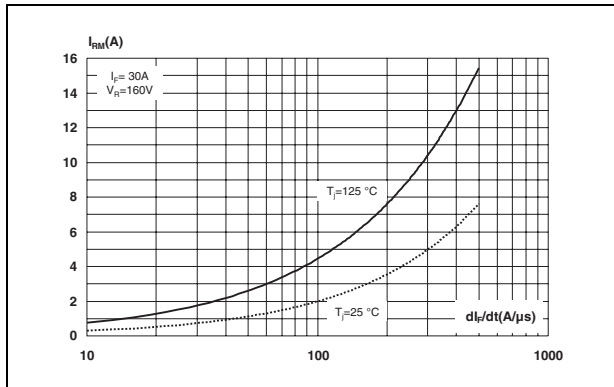

**Figure 8. Dynamic parameters versus junction temperature**

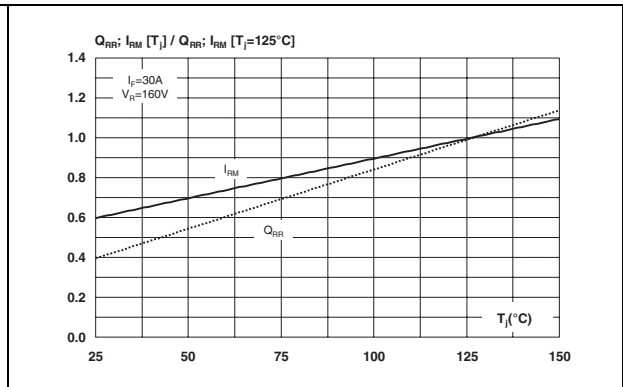

## 2 Ordering information scheme

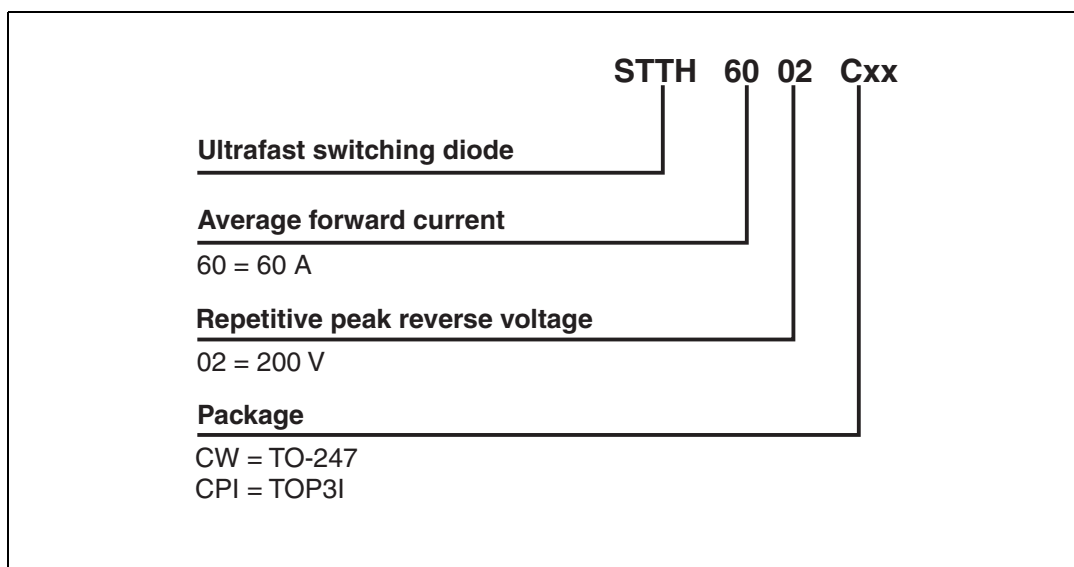

### 3 Package information

Epoxy meets UL94, V0

Cooling method: by conduction (C)

Recommended torque value: 0.8 Nm

Maximum torque value: 1.0 Nm

**Table 5. TO-247 Dimensions**

REF.	DIMENSIONS					
	Millimeters			Inches		
	Min.	Typ	Max.	Min.	Typ	Max.
A	4.85		5.15	0.191		0.203
D	2.20		2.60	0.086		0.102
E	0.40		0.80	0.015		0.031
F	1.00		1.40	0.039		0.055
F1		3.00			0.118	
F2		2.00			0.078	
F3	2.00		2.40	0.078		0.094
F4	3.00		3.40	0.118		0.133
G		10.90			0.429	
H	15.45		15.75	0.608		0.620
L	19.85		20.15	0.781		0.793
L1	3.70		4.30	0.145		0.169
L2		18.50			0.728	
L3	14.20		14.80	0.559		0.582
L4		34.60			1.362	
L5		5.50			0.216	
M	2.00		3.00	0.078		0.118
V		5°			5°	
V2		60°			60°	
Di.	3.55		3.65	0.139		0.143

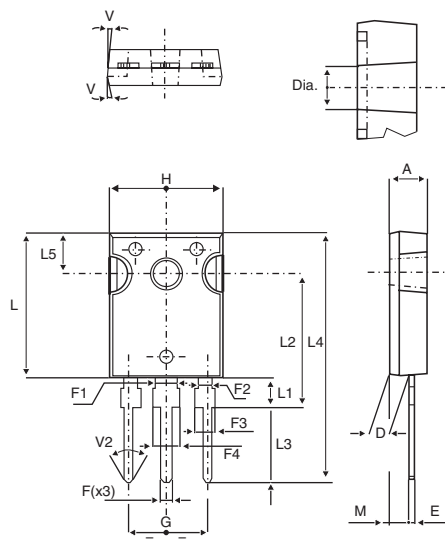

**Table 6. TOP3I dimensions**

REF	DIMENSIONS			
	Millimeters		Inches	
	Min.	Max.	Min.	Max.
A	4.4	4.6	0.173	0.181
B	1.45	1.55	0.057	0.061
C	14.35	15.60	0.565	0.614
D	0.5	0.7	0.020	0.028
E	2.7	2.9	0.106	0.114
F	15.8	16.5	0.622	0.650
G	20.4	21.1	0.815	0.831
H	15.1	15.5	0.594	0.610
J	5.4	5.65	0.213	0.222
K	3.4	3.65	0.134	0.144
ØL	4.08	4.17	0.161	0.164
P	1.20	1.40	0.047	0.055
R	4.60 Typ.		0.181 Typ.	

In order to meet environmental requirements, ST offers these devices in ECOPACK® packages. These packages have a lead-free second level interconnect. The category of second level interconnect is marked on the package and on the inner box label, in compliance with JEDEC Standard JESD97. The maximum ratings related to soldering conditions are also marked on the inner box label. ECOPACK is an ST trademark. ECOPACK specifications are available at: [www.st.com](http://www.st.com).

## 4 Ordering information

Part Number	Marking	Package	Weight	Base qty	Delivery mode
STTH6002CW	STTH6002C	TO-247	4.46 g	30	Tube
STTH6002CPI	STTH6002C	TOP3I	4.7 g	30	Tube

## 5 Revision history

Date	Revision	Description of Changes
Feb-2004	1	First issue
05-Apr-2006	2	Reformatted to current template. Package TOP3I added.



Please Read Carefully:

Information in this document is provided solely in connection with ST products. STMicroelectronics NV and its subsidiaries ("ST") reserve the right to make changes, corrections, modifications or improvements, to this document, and the products and services described herein at any time, without notice.

All ST products are sold pursuant to ST's terms and conditions of sale.

Purchasers are solely responsible for the choice, selection and use of the ST products and services described herein, and ST assumes no liability whatsoever relating to the choice, selection or use of the ST products and services described herein.

No license, express or implied, by estoppel or otherwise, to any intellectual property rights is granted under this document. If any part of this document refers to any third party products or services it shall not be deemed a license grant by ST for the use of such third party products or services, or any intellectual property contained therein or considered as a warranty covering the use in any manner whatsoever of such third party products or services or any intellectual property contained therein.

**UNLESS OTHERWISE SET FORTH IN ST'S TERMS AND CONDITIONS OF SALE ST DISCLAIMS ANY EXPRESS OR IMPLIED WARRANTY WITH RESPECT TO THE USE AND/OR SALE OF ST PRODUCTS INCLUDING WITHOUT LIMITATION IMPLIED WARRANTIES OF MERCHANTABILITY, FITNESS FOR A PARTICULAR PURPOSE (AND THEIR EQUIVALENTS UNDER THE LAWS OF ANY JURISDICTION), OR INFRINGEMENT OF ANY PATENT, COPYRIGHT OR OTHER INTELLECTUAL PROPERTY RIGHT.**

**UNLESS EXPRESSLY APPROVED IN WRITING BY AN AUTHORIZED REPRESENTATIVE OF ST, ST PRODUCTS ARE NOT DESIGNED, AUTHORIZED OR WARRANTED FOR USE IN MILITARY, AIR CRAFT, SPACE, LIFE SAVING, OR LIFE SUSTAINING APPLICATIONS, NOR IN PRODUCTS OR SYSTEMS, WHERE FAILURE OR MALFUNCTION MAY RESULT IN PERSONAL INJURY, DEATH, OR SEVERE PROPERTY OR ENVIRONMENTAL DAMAGE.**

Resale of ST products with provisions different from the statements and/or technical features set forth in this document shall immediately void any warranty granted by ST for the ST product or service described herein and shall not create or extend in any manner whatsoever, any liability of ST.

ST and the ST logo are trademarks or registered trademarks of ST in various countries.

Information in this document supersedes and replaces all information previously supplied.

The ST logo is a registered trademark of STMicroelectronics. All other names are the property of their respective owners.

© 2006 STMicroelectronics - All rights reserved

STMicroelectronics group of companies

Australia - Belgium - Brazil - Canada - China - Czech Republic - Finland - France - Germany - Hong Kong - India - Israel - Italy - Japan - Malaysia - Malta - Morocco - Singapore - Spain - Sweden - Switzerland - United Kingdom - United States of America

[www.st.com](http://www.st.com)

